

# ***Interactive comment on “A new criterion for determining the representative elementary volume of translucent porous media and inner contaminant” by Ming Wu et al.***

**Ming Wu et al.**

jfwu@nju.edu.cn

Received and published: 21 September 2020

Response to Referee #2: Please see the attached PDF file "Response\_to\_HESS\_Referee2\_R1.pdf" in which we have given a point-by-point response to Reviewers' comments. Note that the following text in Arial Narrow font denotes Editor's and Reviewers' comments and in Times New Roman font denotes our response to the comments in the review. In our resubmission, the marked PDF file (Wu\_et\_al\_R1\_marked.pdf) has clearly indicated all changes to the original manuscript. Also, in our marked PDF file, marked in a green strikethrough font is the text that should be removed from the original manuscript and marked in a red font is

[Printer-friendly version](#)

[Discussion paper](#)



the text that has been added to the revision. In addition, Line number(s) mentioned below is referred to as that line numbering in the marked revised manuscript.

Please also note the supplement to this comment:

<https://hess.copernicus.org/preprints/hess-2020-91/hess-2020-91-AC4-supplement.zip>

---

Interactive comment on Hydrol. Earth Syst. Sci. Discuss., <https://doi.org/10.5194/hess-2020-91>, 2020.

## HESSD

---

Interactive  
comment

Printer-friendly version

Discussion paper



Fig. 1

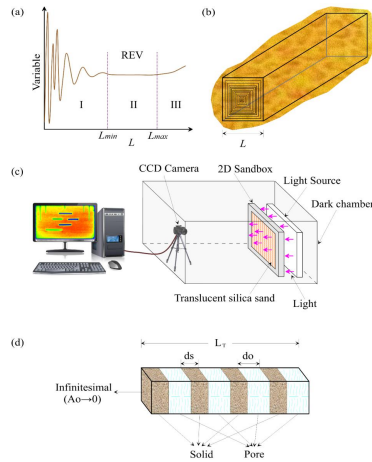

35

**Fig. 1.** (a) Variable changes as measured scale ( $L$ ) increment in conceptual curve (Costanza-Robinson et al., 2011); (b) Scale effect and the cuboid image window geometry; (c) System Device for acquisition of  $p$

Fig. 2

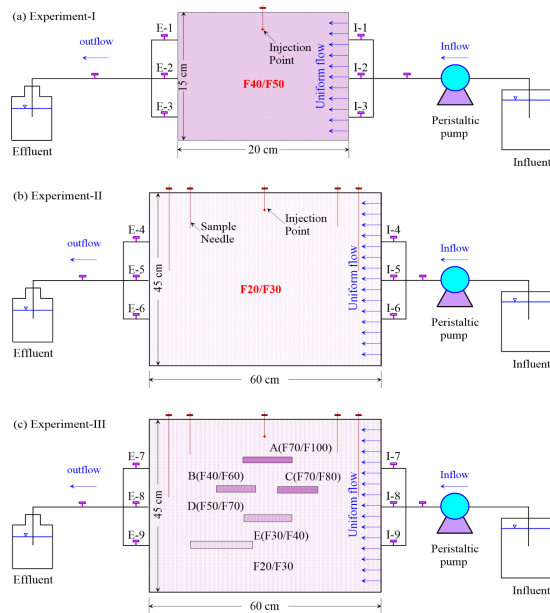

36

**Fig. 2.** (a) The system sandbox equipment of Experiment-I; (b) The system sandbox equipment of Experiment-II; (c) The system sandbox equipment of Experiment-III

Fig. 3

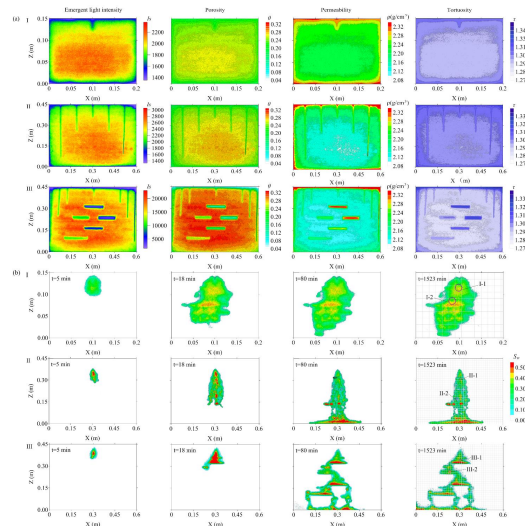

37

**Fig. 3.** (a) The emergent light intensity, porosity, permeability and tortuosity of 2D translucent silica sand for Experiments-I-III; (b) The PCE saturation of Experiments-I-III during 0~152 min and observati

Printer-friendly version

Discussion paper



Fig. 4

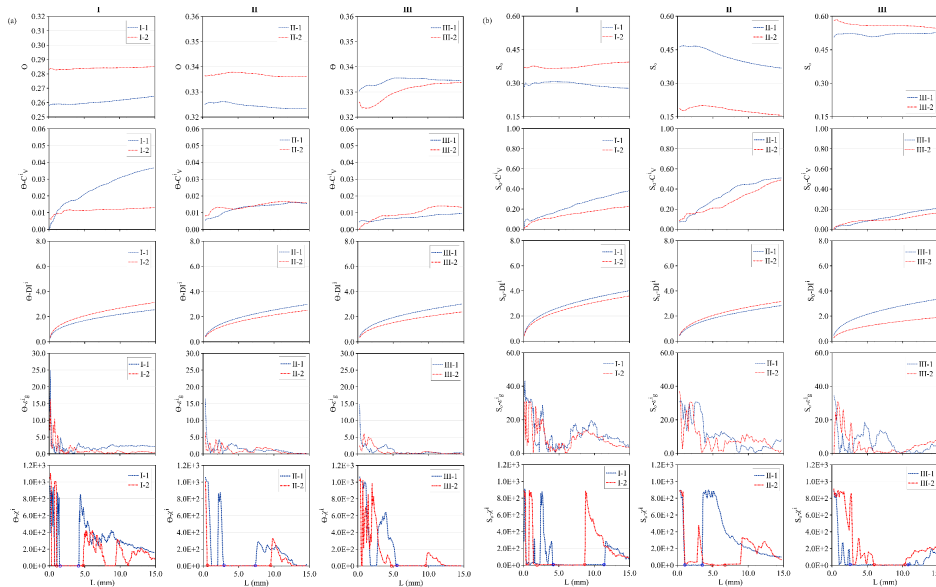

38

**Fig. 4.** (a) The change of porosity ( $\theta$ ), associated coefficient of variation ( $C_V^i$ ), entropy dimension ( $DI^i$ ), the relative gradient error ( $\varepsilon_g^i$ ), and new criterion- $\chi^i$  for observation cells as cuboid window

Printer-friendly version

Discussion paper



Fig. 5

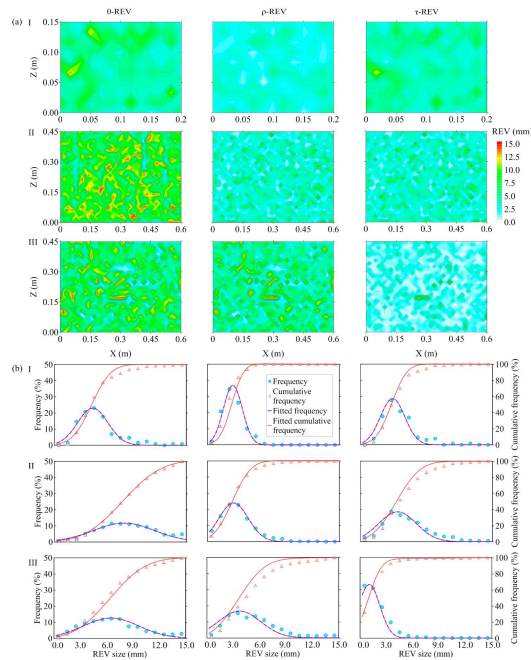

39

**Fig. 5.** (a) The distributions of minimum REV sizes of porosity, sand density and tortuosity for Experiments-I-III; (b) The frequency of minimum REV sizes of Experiments and fitted models

Printer-friendly version

Discussion paper



Fig. 6

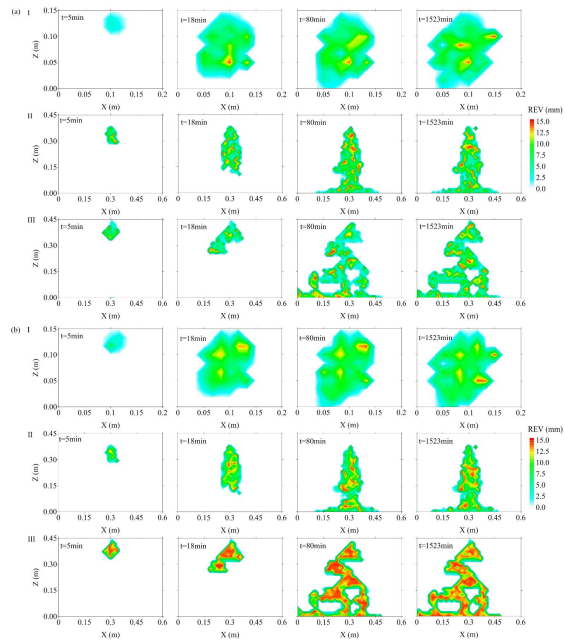

40

**Fig. 6.** (a) The distributions of So-REV sizes during 0~1523 min for Experiments-I-III; (b) The distributions of AOW-REV sizes during 0~1523 min for Experiments-I-III

Printer-friendly version

Discussion paper





Fig. 7

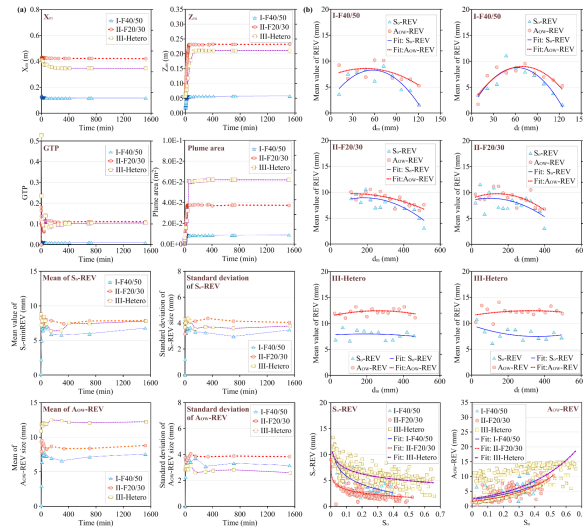

41

**Fig. 7.** (a) The mass center coordinate of PCE plume, GTP, plume area and the mean, standard deviation of So-REV and AOW-REV during 0~1523 min; (b) The change of average REV size as the distance  $d$ ,  $d_m$  increases