

## ***Interactive comment on “A new criterion for determining the representative elementary volume of translucent porous media and inner contaminant” by Ming Wu et al.***

**Ming Wu et al.**

jfwu@nju.edu.cn

Received and published: 21 September 2020

Note that the following text in Arial Narrow font denotes Editor's and Reviewers' comments and in Times New Roman font denotes our response to the comments in the review. In our resubmission, the marked PDF file (Wu\_et\_al\_R1\_marked.pdf) has clearly indicated all changes to the original manuscript. Also, in our marked PDF file, marked in a green strikethrough font is the text that should be removed from the original manuscript and marked in a red font is the text that has been added to the revision. In addition, Line number(s) mentioned below is referred to as that line numbering in the marked revised manuscript.

C1

Response to Anonymous Referee #3's Comments: Review on “A new criterion for determining the representative elementary volume of translucent porous media and inner contaminant” Wu et al. proposed a new criterion to determine the representative elementary volume (REV) of translucent porous media and inner contaminant, compared the new criterion with previous methods in two sandbox experiments, used the new criterion to calculate REV of PCE plume (such as saturation, PCE-water interfacial area), and analyzed the influence of saturation on the REV of saturation and PCE-water interfacial area. Although I do see some improvements of the new criterion in the Figure 4, the current paper is not suitable for the publication in HESS journal and needs major revision. [Response] We appreciate Referee #3's positive comments. Also, we have fully addressed the issues raised by the reviewer and made major revision in the revised manuscript, and given a point-to-point response to the reviewer's comments as follows.

Detailed comments are as follows. Major comments: (1) The title of the paper emphasizes on the new criterion, but only Figure 4 shows the comparison between the new criterion and other methods. Why do you design the new criterion as the current form? Why the new criterion has such improvements compared with other methods? These need to be introduced and discussed. [Response] Comments accepted. We have added more expression into the Introduction section. The new criterion conforms to the Eq. (12). Moreover, the new criterion is proposed based on the dimensionless range  $(\frac{L}{R})$  (Brown and Hsieh, 2000). However,  $(\frac{L}{R}) < 1$  is hard to be achieved. According to the [Eq. (12)], we propose a new criterion and test the effect for translucent porous media. The results suggest the new criterion appears to be the most appropriate criterion for REV plateau identification (Lines 90-93, 253). (2) Half part of the paper focuses on the “REVs of material properties” and “REVs of  $S_o$  and AOW for PCE plume”, but there is no introduction on those topics in the “introduction” section. This makes it confusing on the contribution of this paper as compared with previous research. [Response] Comments accepted. We have added REVs of material properties and PCE saturation, PCE-water interfacial area in the introduction section (Lines 71-72,

C2

84-88). (3) The experimental design is not introduced clearly. For example, why do you use two sandboxes with different materials? Why do the two sandboxes have different size? How to observe different variables with different cuboid window scale? Moreover, I think the method and result are mixed in the current paper. For example, L241-251 and L364-373 are methods instead of the results, so the author should move them to the section 2 to clarify the whole procedure you performed. [Response] Comments accepted. We have added a heterogeneous case (Experiment-III) to validate the applicability of new criteria for REV estimation. The methods are moved to the section 2 (Lines 176-201). (4) The figure organization makes the paper not easy to follow. Figures are introduced from Fig. 1c to Fig. 1a, then to Figs. 2a-b, then back to Fig. 1b. I suggest the author to reorganize the figures just as the orders they appear in the paper. [Response] Comments accepted. We have modified the numbers of figures in Fig. 1 (Lines 653-659, 683-685). (5) Figure 4. I see the difference of REV determined by “the relative gradient error” and “the new criterion method”, which one we should trust? How to approve that the REV calculated by new criterion method is more reliable? Moreover, you can highlight the REV region in Figure 4 so that readers can directly see that. [Response] Comments accepted. The relative gradient error is proposed by previous study and has also used for our research about translucent porous media and contaminants migration. However, random fluctuations exist in curves visually, which make the REV plateau uneasy to be identified. Significantly, the curve of new criterion appears low value interval which makes the beginning and ending of REV plateau easier to be identified. We have used open circles to indicate the REV plateau region in Fig. 4. Readers can see REV plateau estimated by the new criterion. (6) Figure 6. There is not any interpret or discussion on the Figure 6. If the figure is important, please provide detail description. If not, I suggest moving it to the supplementary. [Response] Comments accepted. Fig.7 is obtained on the REV distribution presented in Fig. 6. We have added more discussion about Fig.6 in revised manuscript (Lines 407-419). (7) L383-384. In the downright corner of the Figure 7a, the red line increases first, then decrease. So I do not agree with that “while

C3

REV of PCE plume presents apparent decreasing ... for Experiment-II”. [Response] Comments accepted. We have revised this sentence in revised manuscript (Lines 447-448). Minor comments: (1) L54, “As measured scale size ranging between Lmin and Lmax,” Please give the Lmin and Lmax directly in the figure. [Response] Comments accepted. We have added “Lmin” and “Lmax” in Fig. 1a (Lines 683-685). (2) Is there any reference for the conceptual representation of “REV curve” in L50? [Response] Comments accepted. We have added reference for “REV curve” (Lines 52-53). (3) L142. “Fig. 1c” should be “Fig. 1d”. [Response] Comments accepted. We have made corresponding correction (Line 152). (4) L148. What does “n” mean in the Equation 5? And, the porosity does not occur in the Equation, how do you derive the porosity from it? [Response] Comments accepted. We have replaced ‘n’ with ‘ $\theta$ ’ (Lines 53 and 158). (5) L218-220. What is the difference between the and? Are they the same? [Response] Comments accepted. We have corrected the sub and sup i (Line 255). (6) The author should proofread the paper carefully, as the current paper has numerous typos. For example, L243: “Figure 2c” cannot be found in the paper. L358, “All mean REV sizes of these variables for Experiment-II are larger than REV of Experiments-II”. L386-387, the sentence does not have verb. [Response] Comments accepted. We have checked carefully and corrected these mistakes above (Lines 180, 402 and 431-433).

Please also note the supplement to this comment:

<https://hess.copernicus.org/preprints/hess-2020-91/hess-2020-91-AC2-supplement.zip>

---

Interactive comment on Hydrol. Earth Syst. Sci. Discuss., <https://doi.org/10.5194/hess-2020-91>, 2020.

C4

Fig. 1

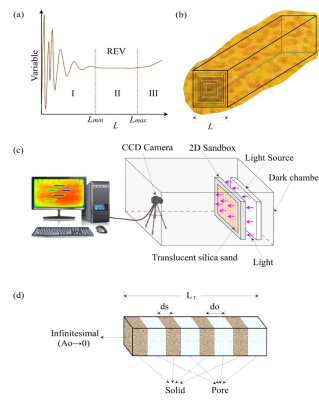

35

**Fig. 1.** (a) Variable changes as measured scale ( $L$ ) increment in conceptual curve (Costanza-Robinson et al., 2011); (b) Scale effect and the cuboid image window geometry; (c) System Device for acquisition of  $p$

C5

Fig. 2

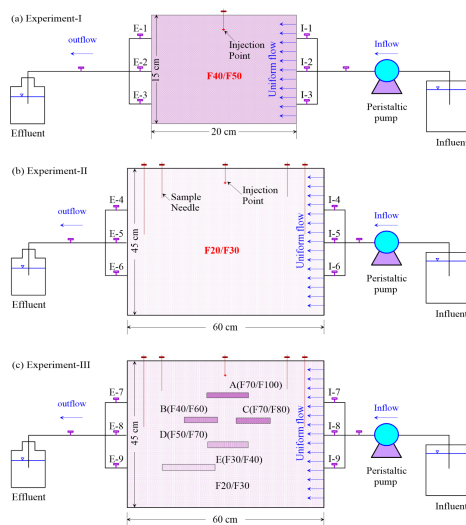

36

**Fig. 2.** (a) The system sandbox equipment of Experiment-I; (b) The system sandbox equipment of Experiment-II; (c) The system sandbox equipment of Experiment-III

C6

Fig. 3

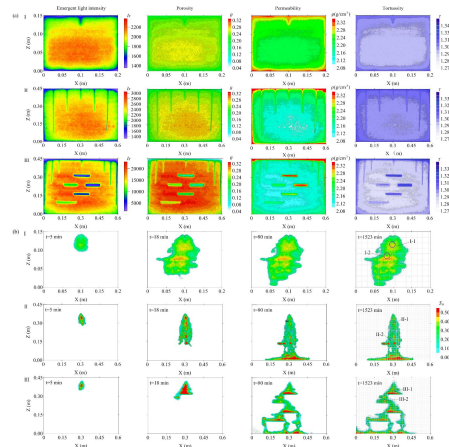

37

**Fig. 3.** (a) The emergent light intensity, porosity, permeability and tortuosity of 2D translucent silica sand for Experiments-I-III; (b) The PCE saturation of Experiments-I-III during 0~1523 min and observati

C7

Fig. 4

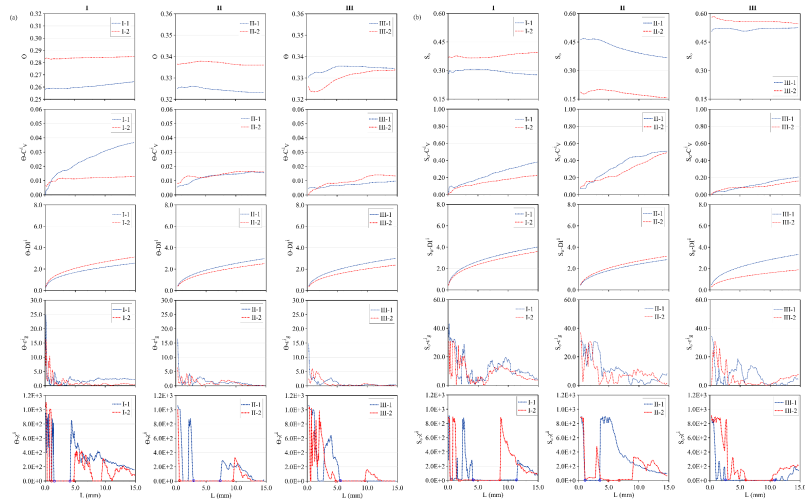

38

**Fig. 4.** (a) The change of porosity ( $\theta$ ), associated coefficient of variation ( $C_V^i$ ), entropy dimension ( $DI^i$ ), the relative gradient error ( $\epsilon_g^i$ ), and new criterion- $\chi^i$  for observation cells as cuboid window

C8

Fig. 5

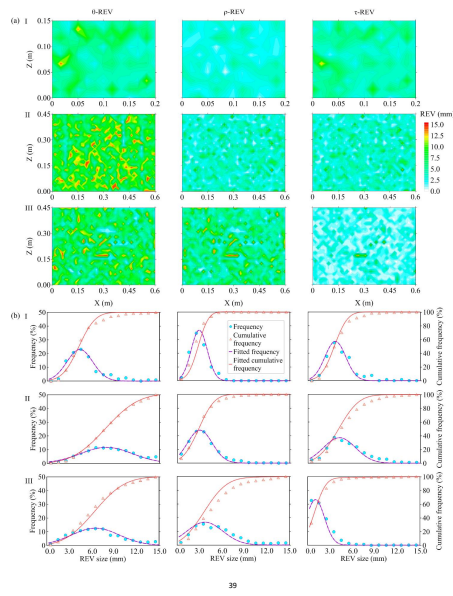

Fig. 5. (a) The distributions of minimum REV sizes of porosity, sand density and tortuosity for Experiments-I-III; (b) The frequency of minimum REV sizes of Experiments and fitted models

C9

Fig. 6

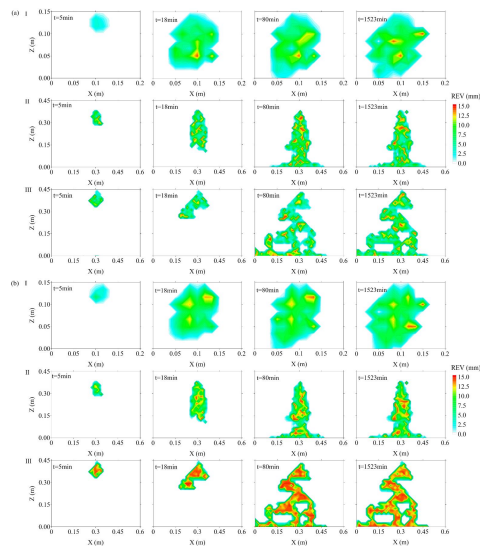
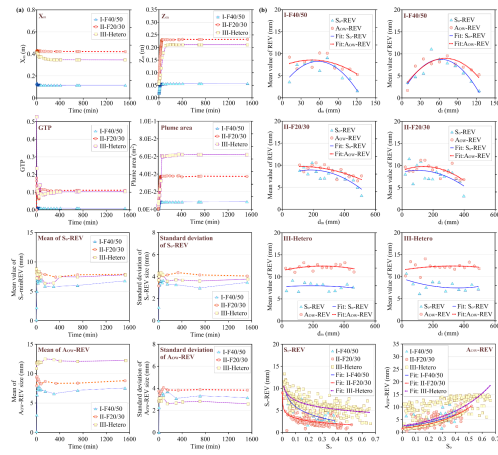

Fig. 6. (a) The distributions of So-REV sizes during 0~1523 min for Experiments-I-III; (b) The distributions of AOW-REV sizes during 0~1523 min for Experiments-I-III

C10

Fig. 7



**Fig. 7.** (a) The mass center coordinate of PCE plume, GTP, plume area and the mean, standard deviation of So-REV and AOW-REV during 0~1523 min; (b) The change of average REV size as the distance  $d_1$ ,  $d_2$  increases