

Q1: Abstract shows some results with lack of valuable conclusions. What's the evidence for "There is a close relationship between the surface water and groundwater." The authors should show some detailed data for the stable isotopic compositions in different water types in the ABSTRACT.

A1: Thanks for your comments. We deleted the sentence of "There is a close relationship between the surface water and groundwater" and added "It could be established that surface water recharges groundwater at 5 sections along the Weihe River, and each section has unique recharge intensity and relationship due to its specific hydraulic environment" of line 21-22.

Q2: The INTRODUCTION does not provide good background to the study and places it in an international context. It is overelaborate without giving a straightforward idea of what the paper would like to present. The authors did not point out the specific aims of this study. What is not clear is what new general information you hope to provide. What new and scientific contribution will come out of this paper?

A2: Thanks for your comments. We have rewritten the introduction and added the specific aims at the end of this section.

'This paper has three main objectives as follows: (1) To investigate the hydrogeochemical components formation of surface water and groundwater through the samplings in several typical sections of the Weihe River Basin; (2) To determine the recharge relationship between surface water and groundwater based on the hydrogeochemical and isotopic characteristics; (3) To provide a series of methods for hydrogeochemical analysis including Piper trilinear diagram, Gibbs diagram, factor analysis and cluster analysis.'

Q3: Study Area: What's the main environmental issue associated with water resources in this study area? Please show the full statement for 'EC,TDS, RDO, WHO' when they first occur in the paper.

A3: Thanks for your comments.

(1) There are two primary reasons why we choose this study area. Firstly, the shallow groundwater along both sides of the water could provide sufficient groundwater samplings for research. Secondly, the influence of river pollutants on groundwater is mainly banded and has a relatively small area of influence and the samplings would cover the influence of pollutants from the Weihe River on groundwater.

(2) All the abbreviation statements are added when they first occur in the paper which are listed as follows:

EC: electrical conductivity (lines 50 and 97)

TDS: total dissolved solids (line 116)

RDO: Rugged Dissolved Oxygen (line 116)

WHO: World Health Organization (line 135)

Q4: Materials and methods: : Line 119:'The principle of division' For this method, does it have assumed condition? If use chloride or other tracers, how about the results? Line 127:'...is

calculated with D as a standard.', please explain it

A4: Thanks for your comments. 'The principle of division' is mainly referred to ' Song Xian-Fang, Liu Xiang-Chao, Xia Jun, Yu Jing-Jie, Tang Chang-Yuan. A study of interaction between surface water and groundwater using environmental isotopes in Huaisha River basin[J]. Science in China (Series D), 2007, 37(1):102-110.' It doesn't belong to assumed condition. And it needs further investigation If chloride or other tracers are used.

Q5: Results and Discussion: Section 3 is too long and tries to describe too many things. The thrust of this paper is to identify the interaction between surface water and groundwater. You should try to keep this as the main focus of the paper. Apart from 3.4.2, most of the contents in the section 3 are results. Line 259: for the data source from the 27 GNIPs set up in China, please add the specific references.

A5: Thanks for your comments.

(1) We have collected 5 surface water and 17 groundwater samplings, then conducted hydrogeochemical tests and diagram analysis upon them. The results are shown in the 'Results and discussion' section, separated by different parts. Each subsection includes results and the according discussion, together with indications and suggestions through the reliable data from samplings in this study area.

The results of both surface water and groundwater are the basis of relationship establishment, so we would like keeping the descriptions combined with discussion.

(2) We added two references related to 27 GNIPs in China. (line 260)

1. ZHANG Mingjun, WANG Shengjie. A review of precipitation isotope studies in China: Basic pattern and hydrological process[J]. Journal of Geographical Sciences, 2016, 26 (7): 921-938.
2. IAEA/WMO, 2015. Global Network of Isotopes in Precipitation. 2015-11-29.

Q6: Conclusions: This section just summarises the main findings of the project. In this section explain in more detail how your project helps us to understand processes in these environments more broadly; the paper will have more impact if researchers from elsewhere in the world can see relevance to their studies and a paper in a major international journal such as HESS needs to have broad appeal.

A6: Thanks for your comments. The main objectives of this paper focus on the hydrogeochemical characteristics and transformation relationships in the Weihe River, therefore, the primary results of this research should be listed in the conclusion section. Moreover, we added some sentences in this section to make sure that the research importance is addressed.

'This paper provides systematical methods for hydrogeochemical components analysis which could contribute to the relationship of surface water and groundwater.'

'The research results need to be improved by sufficient local measured data in future research. Moreover, the methods conducted in this paper could offer a new way of research on surface water and groundwater, and the specific results could also provide valuable information for the local water groundwater protection, restoration and management.'

Q7: Figure 1, please show the coordinates of the map. Could you add the groundwater level contours on Fig. 1? Figure 5, is it for showing the results on groundwater samples? not clear. Please be prudent to use the cluster analysis and avoid the false correlation, especially for the groundwater samples. Figure 6, add 'a' and 'b' for the left and right diagrams, respectively. Add the corresponding figure captions. 'Isotopic variation of surface water' There is only one data for one reach of the river. What's the variation? Figure 7, the types of lines are not clear.

A7: Thanks for your comments.

(1) Considering that four spots are selected for groundwater levels detection and no coordinates are labeled in the published paper referred, we didn't mark the coordinates in Fig. 1. If reviewers are interested, we could arrange a field trip to this region.

(2) We added '(a)' and '(b)' in Figure 5, which represent groundwater variables classification and surface water variables classification respectively. The caption of Fig 5 has been revised.

(3) There are five types of lines in Figure 7 whose legends are already shown. The Global meteoric water line and China line coincide on the top. Then the three lines are Shijiazhuang, Zhengzhou and groundwater samples respectively.

Research on Hydrogeochemical Characteristics and Transformation Relationships between Surface Water and Groundwater in the Weihe River

Shibao Lu¹, Yizi Shang^{2,}, Jihong Ou³, Wei Li¹, Zhipeng Gao^{4,2}, Wujin Li^{5,2}, Zhiping Li², Furong Yu²*

1 School of Resources and Environment, North China University of Water Resources and Electric Power, Zhengzhou 450045, China;

2 State Key Laboratory of Simulation and Regulation of Water Cycle in River Basin, China Institute of Water Resources and Hydropower Research, Beijing 100018, China;

3 School of Public Administration, Zhejiang University of Finance and Economics, Hang Zhou 310018, China;

4 School of Water Resources and Environment, China University of Geosciences (Beijing), Beijing 100083, China

5 Guangdong Hydropower Planning and Design Institute, Guangzhou 510635, China.

**corresponding author: yzshang@foxmail.com*

Jihong Ou[†], Shibao Lu^{2,}, Zhipeng Gao^{2,†}, Wujin Li^{4,†}, Zhiping Li[†], Furong Yu[†]*

([†]School of Resources and Environment, North China University of Water Resources and Electric Power, Zhengzhou 450045, China

²School of Public Administration, Zhejiang University of Finance and Economics, Hang Zhou 310018, China;

³School of Water Resources and Environment, China University of Geosciences (Beijing), Beijing 100083, China

⁴Guangdong Hydropower Planning and Design Institute, Guangzhou 510635, China)

[†]corresponding author: Lu511284@aliyun.com

Abstract: The transforming relationship between surface water and groundwater as well as their origins are the basis for studying the transport of pollutants in river-groundwater systems. ~~At~~Typical sections of the river ~~were~~was chosen to sample the surface water and shallow groundwater. Then, a Piper trilinear diagram, Gibbs diagram, ratios of major ions, factor analysis, cluster analysis and other methods were ~~used~~applied to investigate the hydrogeochemical evolution of surface water and groundwater and determine the formation of hydrogeochemical components in different water bodies. Based on the distribution characteristics of hydrogen and oxygen stable isotopes δD and $\delta^{18}O$ and discharge hydrograph separation methods, the relationship between surface water and groundwater in the Weihe River was analyzed. The results ~~indicated~~reveal that the river water is a SO_4 Cl—Na type and ~~that~~the groundwater hydrogeochemical types are not the same. The dominant anions are HCO_3^- in the upstream reaches and ~~are~~ SO_4^{2-} and Cl⁻ in downstream reaches. Hydrogeochemical processes include evaporation and concentration, weathering of rocks, ion exchange, and dissolution infiltration reactions. The δD and $\delta^{18}O$ of surface water change little along the river and are more enriched than are those of the groundwater. With the influences of precipitation, irrigation, river recharge and evaporation, the δD and $\delta^{18}O$ of shallow groundwater at different sections are not the same. It could be established that surface water recharges groundwater at 5 sections along the Weihe River, and each section has unique recharge intensity and relationship due to its specific hydraulic environment. There is a close relationship between the surface water and groundwater. Surface water supplies the groundwater, which provides the hydrodynamic conditions for the entry of pollutants into the aquifer.

Keywords: hydrogeochemical characteristics; hydrogen and oxygen stable isotopes; surface water-groundwater system; cycle and transformation

1. Introduction

The regularity of the water cycle and the conversion between surface water and groundwater is the basis for the study of pollutant transport in river-groundwater systems (Lu et al., 2016a; Shang et al., 2017). Different water bodies have specific different hydrogeochemical characteristics and isotopic signatures ~~because of~~due to their different ~~sources of~~ recharge sources, environments and circulation conditions. Hence, hydrogeochemical

42 characteristics are ~~the ideal tracers used~~ for ~~displaying tracking~~ water circulation processes ~~and~~. ~~a~~Analyses of
43 hydrogeochemical and isotopic characteristics ~~of rivers and groundwater~~ can effectively reveal the ~~relationship in~~
44 ~~the~~ transformation of river water to groundwater (Kanduč et al., 2014). ~~An integration of the hydrogeological and~~
45 ~~isotopic data could be more reliable and meaningful~~ (Matiatos et al., 2014).

46 A series of mathematical methods are employed and combined to process the measured data. Descriptive
47 statistics, graphic analysis and multivariate statistical analysis methods are used to ~~determine~~analyze the
48 hydrogeochemical characteristics (Lu et al., 2015). ~~Graphic methods include the~~ Durov diagram (1948), Stiff
49 diagram (1951), Piper diagram (1944) and Gibbs diagram (1970) belong to graphical methods (Rekha et al., 2013).
50 Common multivariate statistical analysis methods include factor analysis (Keesari et al., 2016), principal
51 component analysis (Chattopadhyay and Singh, 2103) and cluster analysis (Zhang et al., 2012). Stable isotopes of
52 δD and $\delta^{18}O$ are considered as ideal tracers for tracking various hydrogeochemical processes (Liu et al., 2014).
53 The surface-ground water transformation mechanism is a worldwide topic, about which researches were
54 conducted on many regions via the above methods. Dogramaci et al. (2012) ~~investigated~~studied the
55 hydrogeochemical and isotopic characteristics of the Hamersley Basin in northwestern Australia and provided a
56 theoretical basis for the sustainable development of local water resource utilization. A series of methods, such as
57 ~~The~~ descriptive statistical method, the Piper diagram and the main ion component proportion coefficient and the
58 factor analysis method, were ~~employed~~used to study hydrogeochemical characteristics of groundwater in the Sara
59 Wusu aquifer system in the Ordos Basin (Yang et al., 2016). Fuzzy mathematics and multivariate statistical
60 methods were used to study the quality characteristics of surface water and groundwater in the Songnen plain
61 (Zhang et al., 2012). Zeng et al. (2013) ~~investigated~~studied the spatial distribution of hydrogeochemical and
62 isotopic characteristics of different water bodies in Tajikistan, including spring water, river water and lake water;
63 ~~in different parts of Tajikistan~~ and discussed their origins and environmental significance. ~~Although there are~~
64 ~~many studies related to the chemical and isotopic characteristics of groundwater and surface water, the~~
65 ~~relationship between surface water and groundwater transformation is still a prevalent topic in hydrology and~~
66 ~~water resource studies (Wang et al., 2016; Lu et al., 2016b), hydrogeochemistry, biogeochemistry, and~~
67 ~~ecohydrology.~~ Hydrogen and oxygen stable isotopes ($\delta^{18}O$ and δD) and electrical conductivity (EC) as typical
68 parameters were ~~adopted~~used to ~~represent~~study the mutual relationship among precipitation, river water and
69 groundwater in Taiwan Douliushan (Peng et al., 2014). Meanwhile, Mmultivariate statistical analysis ~~methods~~ and
70 isotopice analysis methods were used to study the hydraulic linkage between surface water and ~~ground~~
71 ~~water~~groundwater and their temporal and spatial variations in the Condamine River in Australia (Martinez et al.,
72 2015). Hydrogen and oxygen isotopes were used to study the relationship of recharge and discharge between the
73 various water bodies on the Portuguese island of Madeira, from which a hydrogeological conceptual model of
74 Madeira Island was established (Prada et al., 2016). By analyzing the hydrogeochemical characteristics of surface
75 water and groundwater in the Heihe River Basin, Nie et al. (2005) identified the transformation relationship
76 between groundwater and surface water in the main stream of Heihe River. ~~Hydrogen and oxygen isotopes and~~
77 ~~water chemistry were used to investigate the relationship between surface water and groundwater of the Second~~
78 ~~Songhua River, and~~ ~~Except for the common relationship determination, the end element method was used to~~
79 ~~quantitatively calculate~~ a conversion proportion between surface water and groundwater of the Second Songhua
80 River was also calculated quantitatively through the end element method (Zhang et al, 2014). Although many
81 studies related to the chemical and isotopic characteristics of groundwater and surface water have been conducted
82 recently, the relationship between surface water and groundwater transformation is still a prevalent and essential
83 topic in hydrology and water resource studies, hydrogeochemistry, biogeochemistry, and ecohydrology (Wang et
84 al., 2016; Lu et al., 2016b)

85 The surface water of Weihe River in this paper is seriously polluted and has become a major pollution source

86 for nearby shallow groundwater. This seriously affects the exploitation, utilization and protection of groundwater
87 resources and endangers the ecological safety and the health of the residents (Lu et al., 2016c). This present study
88 has three main objectives as follows: (1) To investigate the hydrogeochemical components formation of surface
89 water and groundwater through the samples taken from~~The surface water and groundwater were sampled in~~
90 several typical sections of the Weihe River Basin; (2) To ~~to study~~determine the rechargeconversion relationship
91 between surface water and groundwater based on the hydrogeochemical and isotopic characteristics; (3)and T
92 provide ~~at the systematic– methods for hydrogeochemical analysis including Piper trilinear diagram, Gibbs~~
93 diagram, factor analysis and cluster analysis.~~basis for groundwater protection, restoration and management.~~
94

95 2. Materials and methods

96 2.1 Study area

97 The Weihe River Basin, ~~which is with the length of~~ 344.5 km ~~long~~ and ~~has~~ a basin area of 14970 km², is
98 located in the northern part of the Henan Province, south of the North China Plain. It is the main tributary to the
99 Zhangweinan Canal, which is ~~a~~ tributary to the Haihe River. The Weihe River Basin has a typical warm,
100 temperate, continental monsoon climate. It is cold and dry, ~~with minor rain~~ in the winter, hot and rainy in the
101 summer, and the average annual precipitation in the basin is 608 mm (Zhu et al., 2006). The influence of river
102 pollutants on groundwater is mainly banded and has a relatively small rangearea of influence. Considering the
103 shallow groundwater along both sides of the river, ~~a~~ 26.67-km-long segment of the Weihe River between
104 Xizhangzhuang village of Xiaohe Town and Dongwangqiao village of Liyang Town, ~~considering the shallow~~
105 ~~groundwater along both sides of the river,~~ was selected as the study area. ~~This is an area~~ of approximately 160
106 km² (as shown in Fig. 1). The Weihe River Basin is closely related to groundwater, and the polluted river water of
107 the Weihe River is a pollution source of groundwater on both sides of the river. The groundwater is mainly
108 supplied by atmospheric precipitation, lateral seepage, piedmont lateral runoff and canal leakage, and drainage is
109 dominated by artificial extraction and evaporation. Groundwater flows from the southwest to the northeast, which
110 is generally consistent with the topography. The average hydraulic gradient is 1/3000.
111

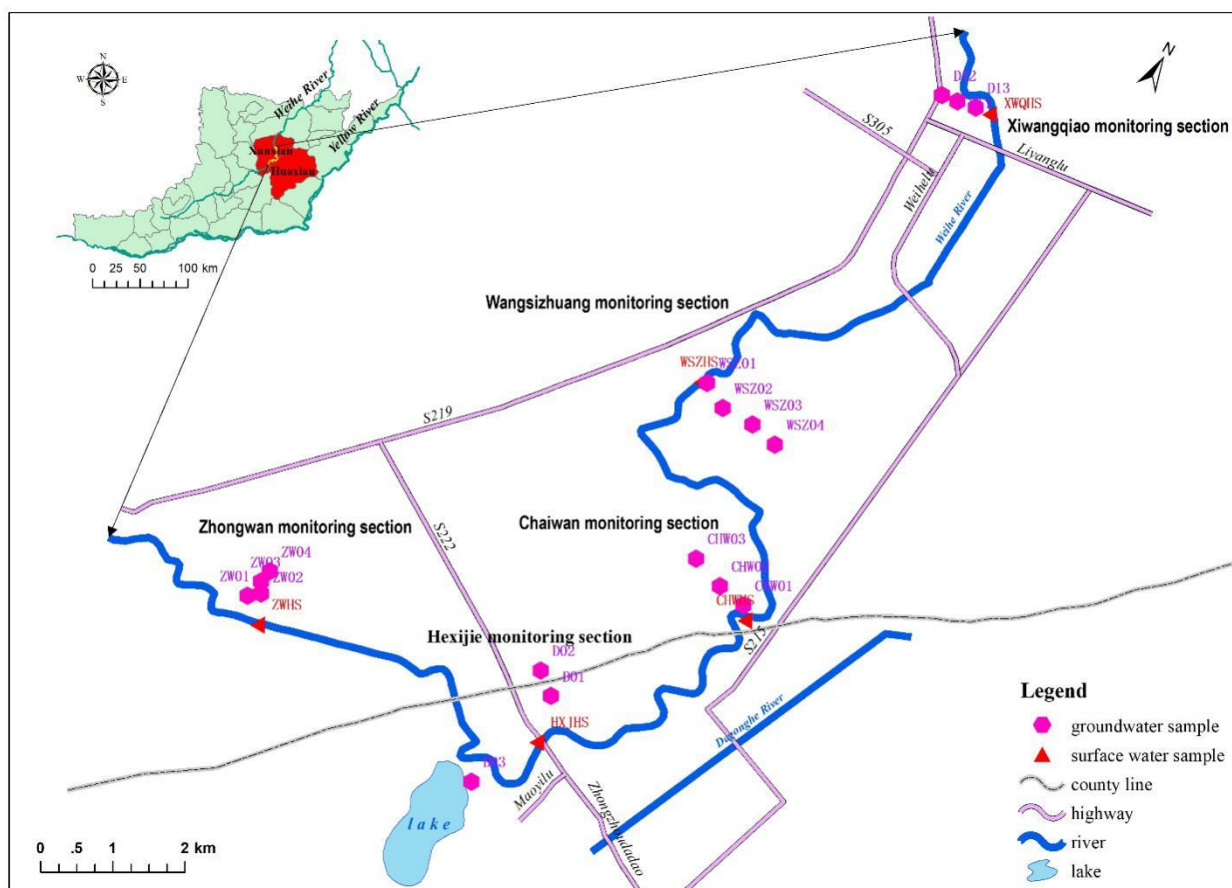

Fig. 1 The location of the study area and the distribution of sampled sections

2.2 Sample collection

According to the goals of the study, the surface water sampling sites were chosen parallel to the direction of river flow, and while the groundwater sampling sites were chosen perpendicular to the river flow. There were 5 sections sampled from upstream to downstream between Xiaohe Town and Liyang Town along the Weihe River (i.e., the Zongwan sample section, Hexijie sample section, Chaiwan sample section, Wangsizhuang sample section and Xiwangqiao sample section). A total of 5 surface water samples and 17 groundwater samples were collected in May 2016. Among them, ZWHS, HXJHS, CHWHS, WSZHS and XWQHS were surface water sampling sites, and the others were groundwater sampling sites. The samples were collected in May 2016. The sampling sites encompassed the band of influence of pollutants from the Weihe River on groundwater. The locations and types of the sampling sites and the types of water samples are shown in Figure 1.

Groundwater was sampled mainly from irrigation wells and drinking wells. Prior to sampling, wells were should be pumped for more than 20 min until the temperature, electrical conductivity (EC), and pH were become stable. Surface water samples were collected from the river bank at a depth of more than 50 cm and kept. Samples were collected in 500 ml polyethylene bottles, which were cleaned-washed with sample water at least three times prior to before sampling. When After sampling work having been finished each sample was collected, it should be confirmed that no bubbles were left in the bottle, and the outer cap was sealed with sealant to prevent air exchange. Samples were brought back to the laboratory and stored in a refrigerated container at 0 to 4 °C.

131 2.3 Stable hydrogen and oxygen isotopes and hydrogeochemical analysis

132 Hydrogen and oxygen isotopes were measured in the laboratory of groundwater science and engineering of
133 the Ministry of Land and Resources of the Institute of Hydrogeology and Environmental Geology at the Chinese
134 Academy of Geological Sciences. Analyses were conducted using wavelength scanning-optical cavity ring down
135 spectroscopy. The ratio of hydrogen and oxygen isotopes (δ) is expressed as the deviation relative to Vienna
136 VSMOW (Zhao, et al, 2015):

$$137 \quad \delta(\text{‰}) = \frac{R_{sp} - R_{st}}{R_{st}} \times 1000 \quad (1)$$

138 where R_{sp} and R_{st} refer to the ratio of D/H (or $^{18}\text{O}/^{16}\text{O}$) in samples and VSMOW, respectively. When δD and
139 $\delta^{18}\text{O}$ are positive, the samples are enriched with D and ^{18}O compared to the VSMOW standard; when they are
140 negative, the two isotopes are diluted compared to the VSMOW standard (Zhang et al., 2006).

141 Analyses of water chemistry components were conducted in the laboratory of hydrogeology
142 at the North China University of Water Resources and Electric Power. The analyses including Cl^- , SO_4^{2-} , Na^+ ,
143 K^+ , NH_4^+ , Mg^{2+} , HCO_3^- , CO_3^{2-} and Ca^{2+} . Among these ions, HCO_3^- and CO_3^{2-} were detected using acid-base
144 indicator titration, Ca^{2+} and Mg^{2+} were tested via EDTA titration, and the other ions were through
145 ion chromatography. pH, total dissolved solids (TDS), dissolved oxygen (DO),
146 conductivity, redox potential and other indicators were detected *in situ* with a PX.68-smarTROLL MP hand-held
147 multi-parameter water quality detector.

148 2.4 Conversion ratio of surface water to groundwater

149 The stable hydrogen and oxygen isotope method can determine the sources of runoff, the division of river
150 runoff and the conversion of surface water and groundwater. The principle of division is based on the law of
151 mass conservation of isotopes (Song et al., 2007), in which the sum of two runoff components is equal to the total
152 flow of the resultant runoff, and the sum of the tracer flow of the two tracer runoff components is equal to the sum of
153 the tracer of synthetic runoff (Figure 2). The calculations basic equations are as follows:

$$154 \quad Q_t = Q_u + Q_v \quad (2)$$

$$155 \quad Q_t \cdot C_t = Q_u \cdot C_u + Q_v \cdot C_v \quad (3)$$

$$156 \quad f = \frac{Q_v}{Q_t} = \frac{C_t - C_u}{C_v - C_u} \quad (4)$$

157 where Q is the flux, C is the isotope concentration component, t and u are indicate surface water, and v
158 represents groundwater. f is the ratio of surface river water to groundwater and is calculated with
159 δD as a standard.

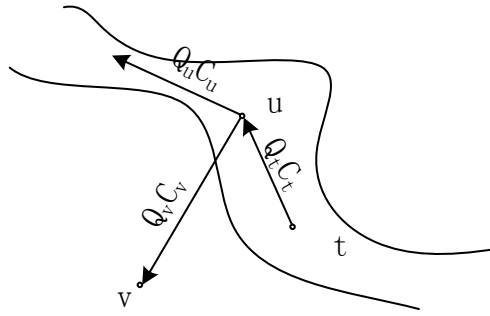

Fig. 2 Principle diagram of the discharge hydrograph separation methods

3. Results and discussion

3.1 Characteristics of main hydrogeochemical components

The water composition results are shown in Table 1. The groundwater pH in the study of the sampling area was near-close to neutral, ranging from 6.83 to 7.81. The TDS ranged from values were between 564.66 and to 1747.84 mg/L, and the TDS of all 17 groundwater samples of which exceeded the World Health Organization (WHO) drinking water standard-threshold of 500 mg/L. As illustrated in Table 1, The relationship between the average concentrations of groundwater anions were sorted as $\text{HCO}_3^- > \text{SO}_4^{2-} > \text{Cl}^-$. The concentration of HCO_3^- ranged from 461.75 mg/L to 735.15 mg/L, with an average concentration of 635.88 mg/L. The concentration of SO_4^{2-} ranged from 116.11 mg/L to 833.33 mg/L, with an average concentration of 307.52 mg/L. The concentration of Cl^- ranged from 102.17 mg/L to 640.13 mg/L, with an average concentration of 275.24 mg/L. The relationship of the average concentrations of the cations was $\text{Na}^+ > \text{Ca}^{2+} > \text{Mg}^{2+} > \text{K}^+$. Na^+ and Ca^{2+} were dominant, and their concentrations ranged from 74.21 mg/L to 272.00 mg/L and 64 mg/L to 268.80 mg/L, respectively, with average values of 182.78 mg/L and 121.69 mg/L.

The pH of the Weihe River in the study area ranged from 8.03 to 8.22, which and was therefore weakly alkaline. The TDS ranged from 1401.32 to 1518.71 mg/L with an average value of 1473.74, which is generally higher than that of groundwater. The sorting results of relationships between the concentrations of anions and cations in surface water were $\text{SO}_4^{2-} > \text{Cl}^- > \text{HCO}_3^-$ and $\text{Na}^+ > \text{Ca}^{2+} > \text{Mg}^{2+} > \text{K}^+$, respectively. The concentration of SO_4^{2-} in the river water ranged from 627.07 mg/L to 664.06 mg/L, with an average value of 647.12 mg/L. The concentration of Cl^- ranged from 325.95 mg/L to 391.57 mg/L, with an average concentration of 365.89 mg/L. The concentrations of Na^+ and Ca^{2+} ranged from 294.47 mg/L to 314.27 mg/L and 94.40 mg/L to 115.20 mg/L, respectively, and their mean values were 305.58 mg/L and 107.52 mg/L. As seen in Table 1, there is no significant change in the ion concentration between the upstream and downstream parts of the Weihe River.

According to WHO standard-of drinking water standards, except for K^+ and pH, the other measured components of surface water and groundwater all exceeded the maximum acceptable values in the study area. As such Under such conditions, both surface water and groundwater along the Weihe River could not be considered as are not suitable drinking water sources.

Table 1 Analytical results of water quality in the study area

Ion content/ (mg.L ⁻¹)		pH	TDS	Na ⁺	K ⁺	Mg ²⁺	Ca ²⁺	Cl ⁻	SO ₄ ²⁻	HCO ₃ ⁻
Groundwater (17)	Minimum	6.73	564.66	74.21	6.20	57.76	64.00	102.17	116.11	461.75
	Maximum	7.81	1747.84	272.00	34.26	162.38	268.80	640.13	833.33	735.15
	Average	7.30	1170.00	182.78	16.58	110.23	121.69	275.24	307.52	635.88

Surface water (5)	Minimum	8.03	1401.32	294.47	24.23	49.90	94.40	325.95	627.07	282.52
	Maximum	8.22	1518.71	314.27	28.35	59.54	115.20	391.57	664.06	385.80
	Average	8.11	1473.74	305.58	26.40	53.79	107.52	365.89	647.12	350.56
WHO drinking water standards		6.5~8.5	500	200	100	30	75	200	200	200
Over-standard rate of groundwater (%)		0	100	47	0	100	70	70	65	100
Over-standard rate of surface water (%)		0	100	100	0	100	100	100	100	100

189

190 3.2 Hydrogeochemical characteristics

191 The Piper diagram is ~~widely one of the most commonly used~~ applied as graphical methods for ~~settling~~
 192 ~~interpreting~~ hydro-geological problems. According to the analytical results, the Piper diagram of the
 193 hydrogeochemical compositions of all water samples in the study area is shown in Fig. 3. The results
 194 ~~illustrate indicate~~ that the chemical type of surface water ~~in the study area is the~~ SO₄ Cl—Na type, indicating that
 195 the surface water is uniform across the study ~~area~~ region. From upstream to downstream along the Weihe River,
 196 the water ~~chemistry~~ chemical type of each groundwater section is as follows: The Zong Wan section and Hexijie
 197 section are mainly HCO₃--Mg Na types, the Chaiwan section is mainly the SO₄ Cl—Mg Na type, the
 198 Wangsizhuang section is mainly the HCO₃ SO₄ Cl—Mg Na type, and the Xiwangqiao section is mainly the
 199 HCO₃ Cl—Mg Ca Na type. ~~From the recharge area to the discharge area, Usually,~~ the chemical types of
 200 groundwater ~~usually, from the recharge area to the discharge area,~~ change in the following ways: HCO₃⁻ —SO₄²⁻
 201 —Cl⁻. ~~Considering Based on the results of groundwater~~ chemical types ~~of groundwater of each section, it could be~~
 202 ~~concluded that~~ HCO₃⁻ is dominant in groundwater on both sides of river in the upstream section, whereas SO₄²⁻
 203 and Cl⁻ are dominant in the middle and lower reaches. The ~~type of water chemistry~~ water chemical types can
 204 indirectly verify ~~that~~ the groundwater flow on both sides of river.

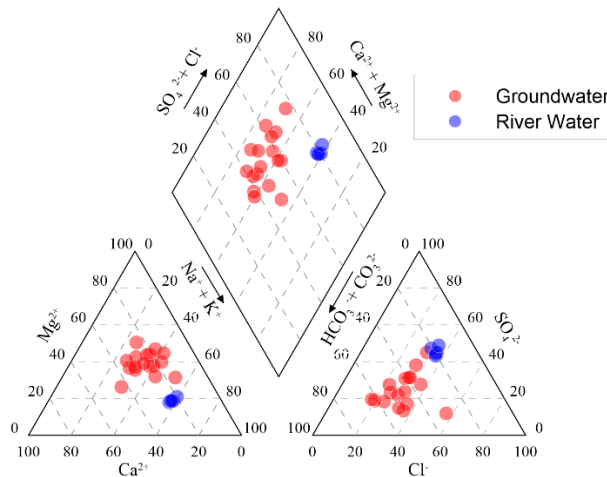

205

206

Fig. 3 Piper diagram of water ~~chemical components~~ for surface and groundwater in the study area

207

3.3 Analysis of formation function of water chemical compositions

208

3.3.1 Analysis of formation function based on the Gibbs diagram

209

210

211

212

The Gibbs diagram can clearly indicate whether the chemical components of river and groundwater are the precipitation dominance type, rock dominance type or evaporation crystallization dominance type. It is an ~~efficient important~~ way to qualitatively determine the effects of regional rocks, atmospheric precipitation, and evaporation concentration on river water components (Wang et al., 2010). Generally, samples with low TDS and

213 high $\text{Na}^+(\text{Na}^+\text{+Ca}^{2+})$ or $\text{Cl}^-(\text{Cl}^+\text{+HCO}_3^-)$ ratios (close to 1), ~~are~~ mainly distributed in the lower-right corner,
 214 ~~indicating~~ indicate precipitation dominance. Samples with slightly high TDS and $\text{Na}^+(\text{Na}^+\text{+Ca}^{2+})$ or
 215 $\text{Cl}^-(\text{Cl}^+\text{+HCO}_3^-)$ ratios of approximately 0.5 or less than 0.5 ~~are~~, mainly distributed in the middle zone, ~~indicating~~
 216 indicate rock dominance. Samples with very high TDS and large $\text{Na}^+(\text{Na}^+\text{+Ca}^{2+})$ or $\text{Cl}^-(\text{Cl}^+\text{+HCO}_3^-)$ ratios, ~~are~~
 217 mainly distributed in the upper-right corner, ~~indicating~~ evaporation crystallization dominance type, reflecting the
 218 influence of evaporation ~~on~~ arid areas (Sun et al., 2014).

219 The ion concentrations of the 5 river ~~surface~~ ground water samples and 17 groundwater samples from the
 220 study area are shown on a Gibbs diagram in Fig. 4. ~~Apparently, It is apparent that~~ the surface water ~~samples in the~~
 221 ~~study area are~~ is distributed ~~located~~ the upper-right corner of the diagram with a $\text{Na}^+(\text{Na}^+\text{+Ca}^{2+})$ or $\text{Cl}^-(\text{Cl}^+\text{+HCO}_3^-)$
 222 ratio greater than 0.5 and ~~with~~ a high content of TDS, ~~which means~~ indicating that surface water has an
 223 evaporation crystallization dominance origin. The groundwater samples differing ~~in~~ the two ~~criteria~~ figures ~~but~~
 224 are mainly distributed in the evaporation crystallization dominance region, slightly towards ~~to~~ the rock dominance
 225 region, indicating that the chemical composition of water is both controlled by evaporation crystallization and
 226 rock weathering.

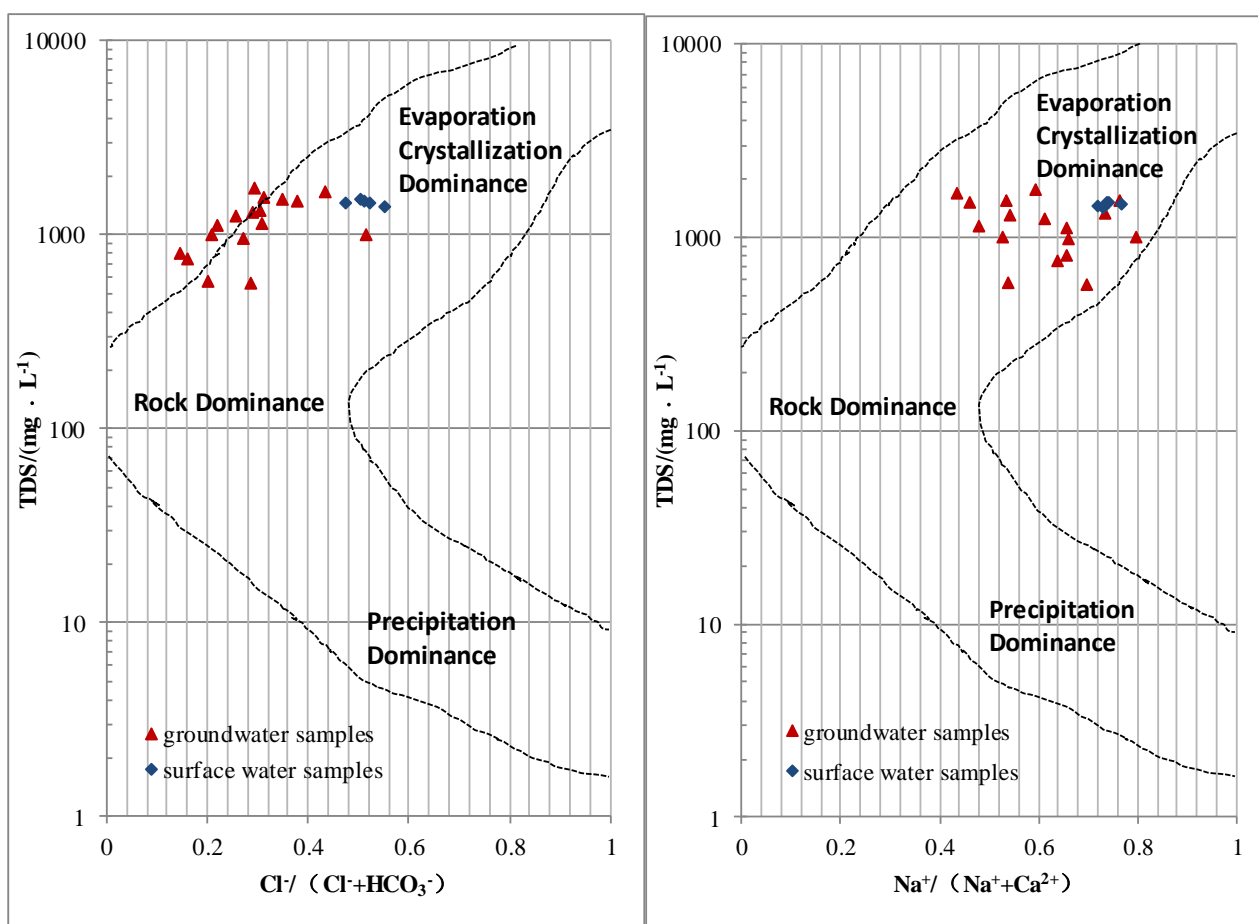

227

228 Fig. 4 Gibbs plots of the ~~surface~~ river and groundwater chemistry in the study area, confirming the type of
 229 evaporation-crystallization dominance, rock weathering dominance and precipitation dominance.

230

231 3.3.3 Analysis of formation function based on multivariate statistics

232 To further analyze the hydrogeochemical formation functions, factor analysis and R cluster analysis were

233 ~~conducted performed~~ on ~~surface and ground water~~ samples using TDS, Cl^- , SO_4^{2-} , HCO_3^- , Na^+ , K^+ , Ca^{2+} , and
 234 Mg^{2+} as the original parameters. ~~Seventeen groups of groundwater samples and 5 groups of surface water samples~~
 235 ~~were calculated. After the calculation, the~~ initial KMO value of the groundwater samples was 0.596. According
 236 to the KMO test standard, ~~when $0.5 < \text{KMO} < 0.6$,~~ the original variable is barely suitable for factor analysis ~~when~~
 237 ~~$0.5 < \text{KMO} < 0.6$.~~ According to the ~~calculation~~ results ~~shown in (Table 2),~~ the formation function of the groundwater
 238 chemical compositions ~~can~~ be summarized in 3 factors, and the cumulative contribution rate of ~~the all~~ 3
 239 factors is 75%. The Ca^{2+} , Cl^- , SO_4^{2-} and TDS of factor 1 have higher positive loads and the coefficient of Ca^{2+} and
 240 SO_4^{2-} is large, indicating that there may be weathering of calcium feldspar, dissolution of gypsum, or oxidation of
 241 pyrite. A large coefficient of Cl^- ~~indicates suggests~~ that there may be leaching of halite. The Na^+ , Mg^{2+} and HCO_3^-
 242 of factor 2 have higher positive loads, which indicates possible weathering of carbonate or silicate. The alternating
 243 adsorption of cations between Na^+ and Ca^{2+} causes the content of Na^+ to increase. The K^+ content of factor 3 is
 244 large, which indicates ~~possible~~ weathering of feldspar. ~~Meanwhile, s~~Surface water samples can be summarized in
 245 2 factors ~~with, and~~ the contribution rate of ~~the 2 factors is~~ 91%. The K^+ , HCO_3^- and TDS of factor 1 have higher
 246 positive loads, indicating the possible weathering of carbonate and feldspar. The Mg^{2+} , Na^+ and Cl^- of factor 2
 247 have ~~a~~ higher positive loads, which indicates the possible dissolution of halite and the alternate adsorption of
 248 cations between Na^+ and Ca^{2+} , ~~which~~ causes the content of Na^+ to increase.

249 Cluster analysis can be simplified as the identification of the relationship between large-scale samples. R
 250 cluster analysis is used to classify variables, ~~while~~ and Q cluster analysis is used to classify samples (Sun and Gui,
 251 2013). The results of the R cluster analysis are shown in Fig. ~~ure~~ 5. The groundwater components can be divided
 252 into 3 groups, which is ~~totally~~ consistent with the results of the factor analysis. ~~The first group includes Ca^{2+} , Cl^- ,~~
 253 ~~SO_4^{2-} and TDS. The second group includes Na^+ , Mg^{2+} and HCO_3^- . Finally, the third group includes K^+ .~~ Surface
 254 water ions can be divided into 2 groups ~~which differ from the results of factor analysis~~. The first group includes
 255 TDS, Cl^- , HCO_3^- , Na^+ , K^+ and Mg^{2+} , and the second group includes Ca^{2+} and SO_4^{2-} . ~~This indicat~~
 256 ~~ing~~ the presence of gypsum dissolution, ~~which differs from the results of factor analysis~~.

257 In summary, a variety of complex hydrogeochemical processes may have occurred in the study area, such as
 258 concentration through evaporation, rock weathering, cation alternate adsorption, oxidation and dissolution.

259
260

Table 2 Factor analysis composition coefficient of ground and surface water

Parameter variable	Groundwater			Surface water	
	Factor 1	Factor 2	Factor 3	Factor 1	Factor 2
Ca^{2+}	0.889	-0.083	0.339	0.206	-0.970
Na^+	0.261	0.799	-0.041	0.650	0.738
K^+	0.061	0.081	0.916	0.783	0.540
Mg^{2+}	0.298	0.702	0.265	0.106	0.986
Cl^-	0.735	0.259	0.323	0.479	0.817
SO_4^{2-}	0.760	0.299	-0.046	-0.883	0.351
HCO_3^-	-0.004	0.915	0.010	0.812	0.151
TDS	0.762	0.197	-0.208	0.972	0.200
Characteristic value	3.472	1.492	1.037	4.856	2.446
Contribution rate%	43.394	18.649	12.965	60.704	30.578
Cumulative contribution rate	43.394	62.043	75.008	60.704	91.282

261

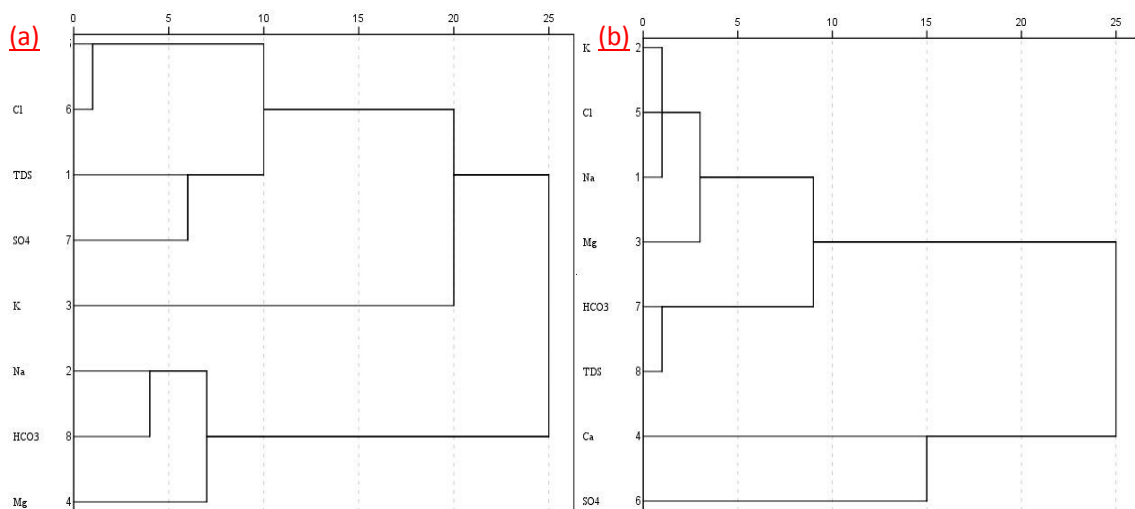

Fig. 5 R type cluster analysis. (a) groundwater variables; (b) surface water variables.

3.4 Isotopic characteristics and transformation relationships of surface water and groundwater

3.4.1 Isotopic variation characteristics

δD and $\delta^{18}O$ of surface water and groundwater and the d value of deuterium excess in the study area are listed in Table 3, in which where $d = \delta D - 8\delta^{18}O$.

As seen in Table 3, δD and $\delta^{18}O$ of surface water are more enriched than in those of groundwater. The variation in δD and $\delta^{18}O$ of surface water from the Weihe River is relatively small. $\delta^{18}O$ ranges from -7.8‰ to -7.6‰ with an average value of -7.7‰, and δD ranges from -59‰ to -57‰ with an average value of -58‰. The range of $\delta^{18}O$ for shallow groundwater is from -9.4‰ to -7.7‰, with an average value of -8.55‰; the range of δD is from -59‰ to -69‰, with an average value of -63.3‰. The d value of deuterium excess of water is positive and less than 10 of the atmospheric precipitation intercept. The value of d of surface water is less than that of shallow groundwater, indicating that the recharge sources of surface water and groundwater are subject to evaporation effects but that shallow groundwater is less influenced by evaporation effects.

Generally, the isotopic characteristics of river water bodies increase from upstream to downstream because of the isotopic fractionation that is caused by the evaporation of water. The fractionation effect on the isotopes could be greater as the location is closer to the lower reaches of the river, the greater the fractionation effect is on the isotopes (Liu et al., 2014). Figure 6 shows the variation in δD and $\delta^{18}O$ in river water. As shown in Fig. 6, it is apparent that δD and $\delta^{18}O$ become more enriched as the river flows downstream, in which $\delta^{18}O$ declines in HXJHS, probably because there is a lake in the vicinity of the upstream reaches and river water supplies the lake.

For groundwater, the values of δD and $\delta^{18}O$ in the Zongwan section, Hexijie section and Xiwangqiao section become more depleted as the distance between sampling points and Weihe River increases. The closer the sample location is to the river, the closer the δD and $\delta^{18}O$ values are to the surface water, revealing that the influence of surface water on groundwater decreases with increasing distance. In contrast, the influence of precipitation and irrigation infiltration recharge on groundwater is enhanced. The values of δD and $\delta^{18}O$ for the Chaiwan section and the Wangsizhuang section become enriched as the distance between the sampling points and the Weihe River increases. The reason is probably that this is likely because the farmland in the Chaiwan section and the Wangsizhuang section is mainly irrigated using Weihe River water, and the infiltration of irrigation water causes the enrichment of hydrogen and oxygen isotopes in the groundwater. The

292 hydrogen and oxygen isotope characteristics are more similar to those of the Weihe River. The CHW02 and
 293 CHW03 sampling points in the Chaiwan section are located in an area affected by river irrigation, and CHW01 is
 294 a household well. ~~As such, the~~ The hydrogen and oxygen isotope values are CHW03 \geq CHW02 $>$ CHW01. Similarly,
 295 WSZ02, WSZ03 and WSZ04 in the Wangsizhuang section are located in an area affected by river irrigation, and
 296 WSZ01 is a household well. Thus, the hydrogen and oxygen isotope values are WSZ04 \geq WSZ03 \geq WSZ02 $>$
 297 WSZ01.

298 -
 299

Table 3 δD , $\delta^{18}O$ and d values of water samples in study area

Water sample type	No.	$\delta D/\text{‰}$	$\delta^{18}O/\text{‰}$	$d/\text{‰}$	$f/\%$
Surface water	ZWHS	-59	-7.7	2.6	
	HXJHS	-58	-7.8	4.4	
	CHWHS	-58	-7.7	3.6	
	WSZHS	-58	-7.7	3.6	
	XWQHS	-57	-7.6	3.8	
	average	-58	-7.7	3.6	
Shallow groundwater	ZW01	-62	-8.6	6.8	33.3
	ZW02	-63	-8.6	5.8	25
	ZW03	-63	-8.6	5.8	25
	ZW04	-69	-9.4	6.2	10
	D01	-65	-8.7	4.6	14.3
	D02	-66	-8.9	5.2	12.5
	D03	-60	-8	4	50
	CHW01	-63	-8.6	5.8	20
	CHW02	-62	-8.4	5.2	25
	CHW03	-62	-8.3	4.4	25
	WSZ01	-68	-9.2	5.6	10
	WSZ02	-63	-8.6	5.8	20
	WSZ03	-63	-8.5	5	20
	WSZ04	-63	-8.5	5	20
	D11	-59	-7.7	2.6	50
	D12	-62	-8.4	5.2	20
	D13	-63	-8.4	4.2	16.7
Average	-63.3	-8.55	5.1		

300

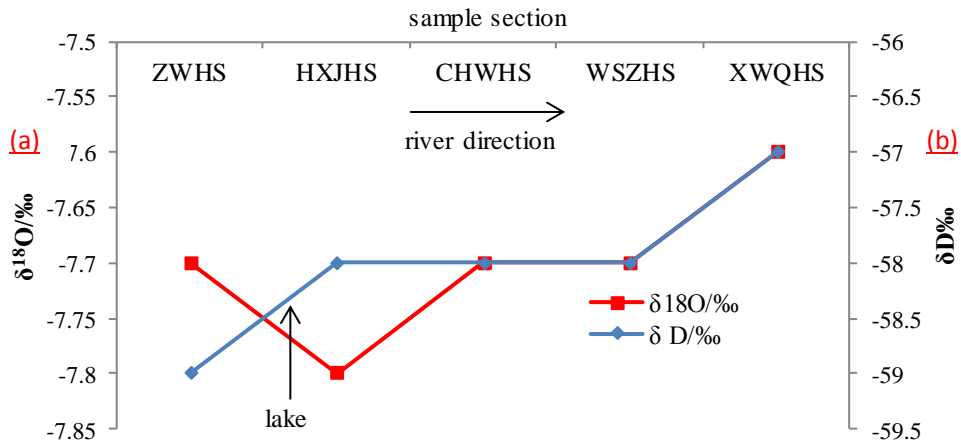

Fig. 6 Isotopic variation of surface water. (a) $\delta^{18}\text{O}$; (b) δD

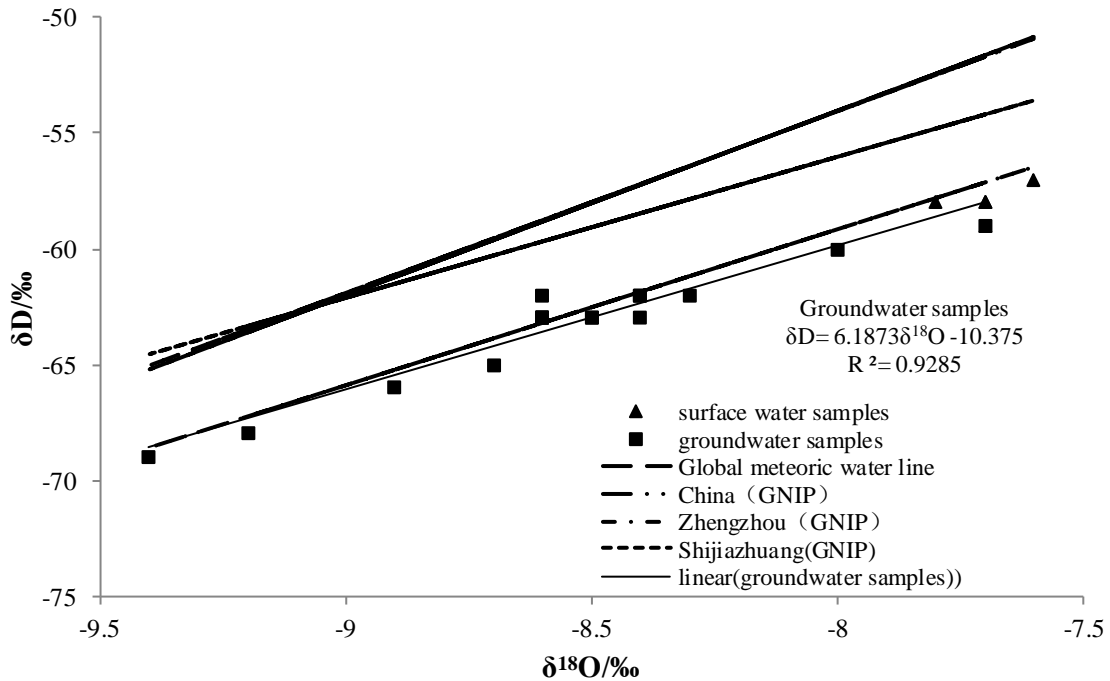

Fig. 7 Relationship between δD and $\delta^{18}\text{O}$ of surface water and groundwater

303
304
305

306 According to the 27 [Global Network of Isotopes in Precipitations \(GNIPs\)](#) set up in China by the
 307 International Atomic Energy Association (IAEA), the monitoring sites that [could be considered as substitutes](#)
 308 [for are closest to](#) the study area are at Shijiazhuang and Zhengzhou ([IAEA/WMO, 2015; Zhang and Wang, 2016](#)).
 309 The meteoric water line [of](#) $\delta\text{D}=6.75 \delta^{18}\text{O}-5.12$ in Zhengzhou is close to the characteristic line for hydrogen and
 310 oxygen isotopes of samples in [the this study area region](#) (Figure 7), [so the meteoric water line in](#)
 311 [Zhengzhou which](#) is [taken as assumed to be](#) the local meteoric water line (LMWL). When the compositions of δD
 312 and $\delta^{18}\text{O}$ [of water samples](#) are compared to the meteoric water line, the source of the local river water and shallow
 313 groundwater and their mutual transformation relationship can be distinguished. [From drawing](#) the trend line
 314 [between of](#) the [underground water groundwater](#) sample points, the relationship between δD and $\delta^{18}\text{O}$ is
 315 $\delta\text{D}=6.1873\delta^{18}\text{O}-10.375$, [and the with a](#) correlation coefficient [of is](#) 0.9285. [From drawing](#) the trend line [between of](#)
 316 [the the](#) groundwater and surface water sample points, the relationship between δD and $\delta^{18}\text{O}$ is [fitted with](#)
 317 $\delta\text{D}=6.19328\delta^{18}\text{O}-10.321$, [and and](#) the correlation coefficient [is is](#) 0.9585. The two trend lines are [basically the](#)

318 ~~same extremely close with, and the~~ high related coefficient ~~is very high~~. The surface water sample points are
319 located in the direction of the groundwater trend line that extends to the right. δD and $\delta^{18}O$ are relatively enriched,
320 indicating that the sources of surface water and groundwater are the same and that there is a hydraulic connection.
321 ~~The hydraulic connection between the two is, i.e.~~ a single-line infiltration of the surface river water into
322 groundwater. The trend line is close to the local meteoric water line (LMWL) and the slope is small, which
323 ~~means indicating~~ that surface water and groundwater are recharged from meteoric water but ~~are~~ also subject to the
324 evaporation, resulting in the enrichment of hydrogen and oxygen isotopes.

325 3.4.2 Estimation of recharge capacity of river water to groundwater

326 According to the stable isotope signatures of the water samples, the calculated results of ratio f of
327 groundwater recharge to river water are shown in Table 43. ~~As illustrated in Fig. 8, except for regular pattern, t~~
328 ~~ratio f of surface water infiltration to recharge groundwater in each observation section~~ also shows ~~has a~~
329 ~~difference, but regular, pattern, and the results are shown in Figure 8.~~

330 In the Zongwan section (Fig. ~~gure~~ 8a), as the distance between groundwater sampling sites and the river
331 increased (ZW01 toward ZW04), the ratio of surface water infiltration to groundwater recharge (f) decreased from
332 33.3% to 10%, ~~confirming indicating~~ that the river water recharges groundwater in this section and the direction
333 of groundwater flow is from ZW01 toward ZW04. The infiltration rates at D01 and D02 in the Hexijie section
334 (~~Figure Fig.~~ 8b) are 14.3% and 12.5% ~~,~~ respectively, ~~and with~~ from the decreasing trend, it can be
335 ~~deduced indicating~~ that there is a small amount of river water recharging groundwater in that section, with a
336 direction of groundwater flow from D01 toward D02. The ratio of surface water infiltration to groundwater at D03
337 is as high as 50%, indicating which means that the river mainly recharges the artificial lake that exists near D03 in
338 the Hexijie section. The ratio of surface water infiltration to groundwater in the Chaiwan section (Fig. ~~ure~~ 8C)
339 increases from 20% to 25% as the distance increases between groundwater sampling sites and the river, whereas it
340 increases from 10% to 20% in the Wangsizhuang section (~~Figure Fig.~~ 8D). This may be associated with the unique
341 river trend of the two sections. The Chaiwan section and the Wangsizhuang section are located near the right
342 corner of the river, where the influence of ~~the~~ river water on groundwater is complicated, but the river is the main
343 supply ~~ier~~ of groundwater. The groundwater flow line is an the enclosed space where ~~there water~~ is no water
344 ~~exchanged~~ with the outside ~~world~~. ~~Some~~ input values like δD and $\delta^{18}O$ remain constant along the entire
345 streamline, ~~such as δD and $\delta^{18}O$, inferring. Therefore, it is possible to interpret~~ that WSZ01, WSZ02, and WSZ03
346 are on the same streamline. At the same time, because farmland is primarily irrigated by ~~water from~~ the Weihe
347 River, irrigation water infiltrates the soil to recharge groundwater, resulting in the enrichment of hydrogen and
348 oxygen isotopes. For the Xiwangqiao section (Fig. ~~ure~~ 8e), the ratio of river water infiltration to groundwater at
349 D11 is close to 50%, whereas it is 20% and 16.7% at D12 and D13, respectively. This is primarily because D11 is
350 located in the convexity of the river, where it is significantly eroded with a large amount of infiltration.

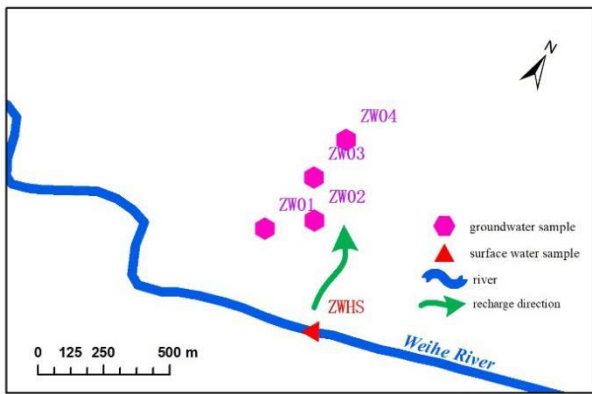

(a) Zongwan section

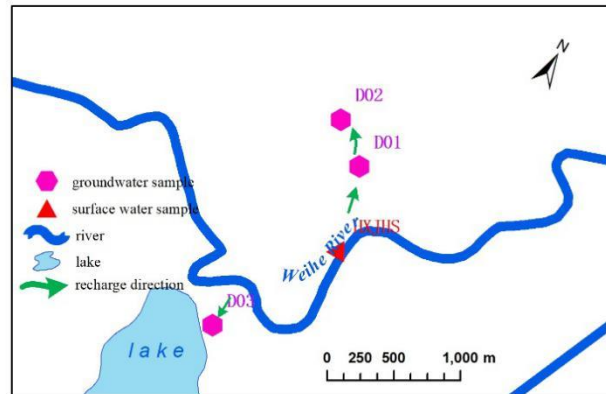

(b) Hexijie section

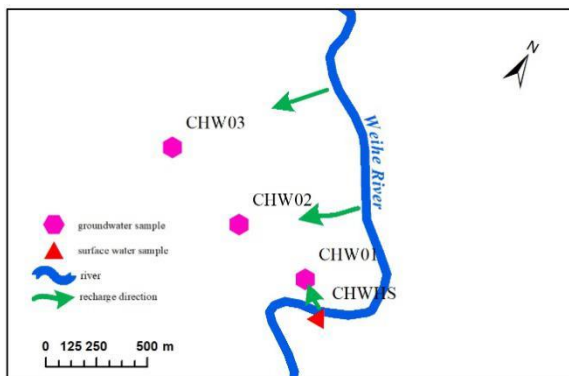

(c) Chaiwan section

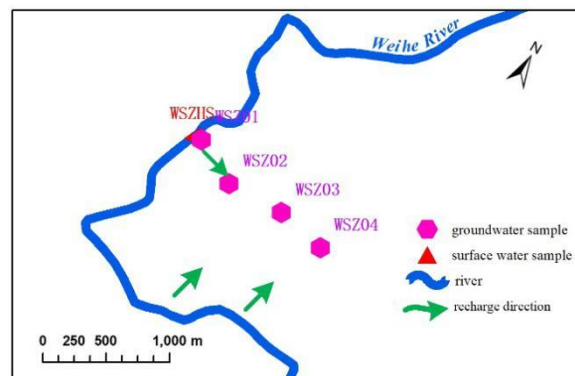

(d) Wangsizhuang section

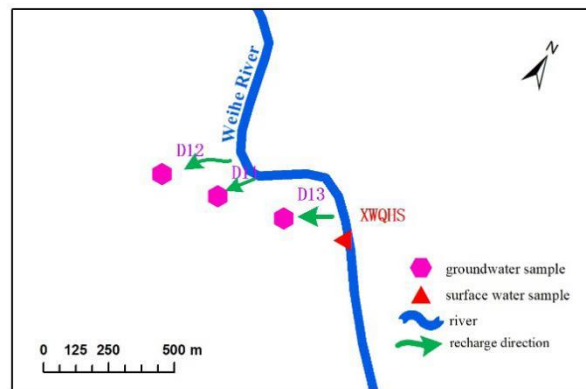

(e) Xiwangqiao section

Fig. 8 Relationships between Recharge directions between surface water and groundwater at all sampling sections

4. Conclusions

This paper provides systematical methods for hydrogeochemical components analysis which could contribute to the relationship of surface water and groundwater. The main results are concluded as follows:

(1) The surface water components of Weihe River ~~display~~ have no significant spatial variations, but the ion concentrations of groundwater samples from 5 sections are different. The cation concentrations of surface water and groundwater are consistent, with $\text{Na}^+ > \text{Ca}^{2+} > \text{Mg}^{2+} > \text{K}^+$. The relative concentrations of anions in groundwater are $\text{HCO}_3^- > \text{SO}_4^{2-} > \text{Cl}^- > \text{NO}_3^-$, whereas the relative concentrations of anions in the surface water are $\text{SO}_4^{2-} > \text{Cl}^- > \text{NO}_3^- > \text{HCO}_3^-$.

365 $\text{HCO}_3^- > \text{NO}_3^-$. The surface water in all sections of the Weihe River is the $\text{SO}_4 \text{Cl}-\text{Na}$ type, whereas the
366 hydrogeochemical types of groundwater are ~~not the same~~-different. HCO_3^- dominates in the groundwater in the
367 upper reaches of the river, ~~and while~~ SO_4^{2-} and Cl^- dominate in the middle and lower reaches.

368 ~~(2) By using~~Based on a Gibbs diagram, factor analysis and cluster analysis, we established that the
369 geochemical processes of the Weihe River Basin include concentration by evaporation, rock weathering, cation
370 alternate adsorption and dissolution. Because surface water is an open system, the source of ions in a water body
371 is greatly influenced by human activity and atmospheric precipitation, whereas the factors contributing to the
372 formation of water chemistry are more complex.

373 ~~(3) The~~ isotope results show that δD and $\delta^{18}\text{O}$ of the surface water in the Weihe River ~~of small variations~~
374 ~~varies little are~~and is more enriched than ~~those of~~ the groundwater ~~is~~. ~~Affected by rainfall, irrigation, river~~
375 ~~recharge and evaporation, t~~The shallow groundwater at different sections ~~is affected by rainfall, irrigation, river~~
376 ~~recharge and evaporation, resulting in~~have different δD and $\delta^{18}\text{O}$ values. By analyzing hydrogen and oxygen
377 isotopic characteristics of surface water and groundwater in different sections and using the segmentation of flow
378 duration curve, it was established that surface water recharges groundwater at 5 sections along the Weihe River,
379 and each section has unique recharge intensity and relationship due to its ~~specific unique~~-hydraulic environment.

380 ~~However, d~~Due to the lack of local isotope monitoring data for meteoric water, the Zhengzhou meteoric
381 water line was used to analyze the isotopic characteristics of surface water and groundwater. The existing
382 household wells, ~~were~~ used as groundwater sampling points, ~~Because they~~ are affected by towns and villages
383 surrounding the Weihe River, ~~causing that~~ groundwater sampling points cannot be fully symmetric and isometric
384 relative to the Weihe River. ~~As such, t~~The research results need to be improved by ~~sufficient monitoring more~~
385 ~~local measured complete~~ data in future research. ~~Moreover, the methods conducted in this paper could offer~~
386 ~~efficient ways of research on surface water and groundwater, and the specific results could also provide valuable~~
387 ~~information for the local water groundwater protection, restoration and management.~~

389 Acknowledgments

390 The study was financially supported by Non-Profit Industry Specific Research Projects of Ministry of Water
391 Resources, China, Grant NO: 201401041 and 201501008, the Open Research Fund of State Key Laboratory of
392 Simulation and Regulation of Water Cycle in River Basin (China Institute of Water Resources and Hydropower
393 Research), Grant NO: IWHR-SKL-201208, and Science and Technology Research Key Project of the Education
394 Department of Henan Province, Grant NO: 14A170006.

395 References

- 396 Chattopadhyay Pallavi Banerjee, Singh, V. S. Hydrochemical evidences: Vulnerability of atoll aquifers in Western Indian Ocean to
397 climate change[J]. *Global & Planetary Change*, 2013, 106:123-140.
- 398 Dogramaci Shawan, Skrzypek Grzegorz, Dodson Wade Pauline F. Stable isotope and hydrochemical evolution of groundwater in the
399 semi-arid Hamersley Basin of subtropical northwest Australia[J]. *Journal of Hydrology*, 2012, 475 (26): 281-293.
- 400 [IAEA/WMO. 2015. Global Network of Isotopes in Precipitation. 2015-11-29.](#)
- 401 [Kanduč T, Grassa F, McIntosh J, et al. A geochemical and stable isotope investigation of groundwater/surface-water interactions in](#)
402 [the Velenje Basin, Slovenia\[J\]. *Hydrogeology Journal*, 2014, 22\(4\): 971-984.](#)
- 403 Keesari Tirumalesh, Ramakumar K.L., Chidambaram S., Pethperumal S., Thilagavathi R. Understanding the hydrochemical behavior
404 of groundwater and its suitability for drinking and agricultural purposes in Pondicherry area, South India – A step towards
405 sustainable development[J]. *Groundwater for Sustainable Development*, 2016, 2-3, 143-153.
- 406 Liu Fen, Wang Shui-Xian, Lan Yong-Chao, Hu Xing-lin. Environmental isotopes and exchanges of surface-water-groundwater

407 system in the Zhangye basin of Heihe River watershed[J]. *South-to-North Water Transfers and Water Science & Technology*,
408 2014, 12(2): 92-96. [\(In Chinese\)](#)

409 Lu Shi-Bao, Bao Hai-Jun, Pan Hu-Lin. Urban water security evaluation based on similarity measure model of Vague sets[J].
410 *International Journal of Hydrogen Energy*, 2016c, 41(35):15944-15950.

411 Lu Shi-Bao, Wang Jian-Hua, Pei Liang. Study on the Effects of Irrigation with Reclaimed Water on the Content and Distribution of
412 Heavy Metals in Soil[J]. *International Journal of Environmental Research & Public Health*, 2016b, 13(3): 298.

413 Lu Shi-Bao, Pei Liang, Bai Xiao. Study on method of domestic wastewater treatment through new-type multi-layer artificial
414 wetland[J]. *International Journal of Hydrogen Energy*, 2015, 40(34):11207-11214.

415 Lu Shi-Bao, Zhang Xiao-Ling, Bao Hai-Jun, Skitmore Martin. Review of social water cycle research in a changing environment[J].
416 *Renewable & Sustainable Energy Reviews*, 2016a, 63:132-140.

417 [Matiatos I, Alexopoulos A, Godelitsas A. Multivariate statistical analysis of the hydrogeochemical and isotopic composition of the
418 groundwater resources in northeastern Peloponnesus \(Greece\)\[J\]. *Science of the Total Environment*, 2014, 476: 577-590.](#)

419 Martinez Jorge L., Raiber Matthias, Cox Malcolm E. Assessment of groundwater–surface water interaction using long-term
420 hydrochemical data and isotope hydrology: Headwaters of the Condamine River, Southeast Queensland, Australia[J]. *Science of
421 the Total Environment*, 2015, 536:499-516.

422 Ma Rui, Dong Qi-Ming, Sun Zi-Yong, Zheng Chun-Miao. Using heat to trace and model the surface water-groundwater interactions:
423 a review[J]. *Geological Science and Technology Information*, 2013, 32 (2):131-137.

424 Nie Zhen-Long, Chen Zong-Yu, Chen Xu-Xue, Hao Ming-Lin, Zhang Guang-Hui. The chemical information of the interaction of
425 unconfined groundwater and surface water along the Heihe River, Northwestern China[J]. *Journal of Jilin University (Earth
426 Science Edition)*, 2005, 35(1):48-51.

427 Prada Susana, Cruz J. Virg ío, Figueira Celso. Using stable isotopes to characterize groundwater recharge sources in the volcanic
428 island of Madeira, Portugal[J]. *Journal of Hydrology*, 2016, 536:409-425.

429 Peng Tsung-Ren, Lu Wan-Chung , Chen Kuan-Yu, Zhan Wen-Jun, Liu Tsung-Kwei. Groundwater-recharge connectivity between a
430 hills-and-plains' area of western Taiwan using water isotopes and electrical conductivity[J]. *Journal of Hydrology*, 2014,
431 517:226-235.

432 [Rekha V B, George A V, Rita M. A Comparative Study of Ion Chemistry of Groundwater Samples of Typical Highland and Midland
433 Sub-watersheds of the Manimala River Basin, Kerala, South India\[J\]. *Environmental Research, Engineering and Management*,
434 2013, 66\(4\): 22-33.](#)

435 Shang Yi-Zi, Lu Shi-Bao, Li Xiao-Fei, Hei Peng-Fei, Lei Xiao-Hui, Gong Jia-Guo, Liu Jia-Hong, Zhai Jia-Qi, Wang Hao. Balancing
436 development of major coal bases with available water resources in China through 2020[J]. *Applied Energy*, 2017, 194:735-750.

437 Song Xian-Fang, Liu Xiang-Chao, Xia Jun, Yu Jing-Jie, Tang Chang-Yuan. A study of interaction between surface water and
438 groundwater using environmental isotopes in Huaisha River basin[J]. *Science in China (Series D)*, 2007, 37(1):102-110.

439 Sun Lin-Hua, Gui He-Rong. Statistical analysis of deep groundwater geochemistry from Taoyuan Coal Mine, northern Anhui
440 Province[J]. *Journal of China Coal Society*, 2013, 38(s2):442-447.

441 Sun Peng-Fei, Yi Ji-Tao, Xu, Guang-Quan. Characteristics of water chemistry and their influencing factors in subsidence waters in
442 the Huainan and Huaibei mining areas, Anhui Province[J]. *Journal of China Coal Society*, 2014, 39(7):1345-1353.

443 Wang Jian-Hua, Lu Shi-Bao, Pei Liang. Study on rules of dynamic variation of nitrogen in soil after reclaimed water drip irrigation[J].
444 *International Journal of Hydrogen Energy*, 2016, 41(35):15938-15943.

445

446 Wang Ya-Ping, Wang Lan, Xu Chun-Xue, Yang Zhong-Fang, Ji Jun-Feng, Xia Xue-Qi, An Zi-Yi, Yuan Jian. Hydro-geochemistry and
447 genesis of major ions in the Yangtze River, China[J]. *Geological Bulletin of China*, 2010, 29(2-3):446-456. [\(In Chinese\)](#)

448

449 Yang Qing-Chun, Wang Lu-Chen, Ma Hong-Yun, Yu Kun, Mart ín Jordi Delgado. Hydrochemical characterization and pollution
450 sources identification of groundwater in Salawusu aquifer system of Ordos Basin, China[J]. *Environmental Pollution*, 2016,

451 216:340-349.

452 Zhao Shi-Kun, Pang Shuo-Guang, Wen Rong, Liu Zhong-Fang. Influence of below-cloud secondary evaporation on stable isotope
453 composition in precipitation in the Haihe River Basin, China[J]. *Progress in Geography*, 2015, 34 (8):1031-1038.

454 Zeng Hai-Ao, Wu Jing-Lu. Water isotopic and hydrochemical characteristics and causality in Tajikistan[J]. *Advances in Water
455 Science*, 2013, 24(2):272-279.

456 Zhang Bing, Song Xian-Fang, Zhang Ying-Hua, Han Dong-Mei, Tang Chang-Yuan, Yu Li-Lei, Ma Ying. Hydrochemical
457 characteristics and water quality assessment of surface water and groundwater in Songnen plain, Northeast China[J]. *Water
458 Research*, 2012, 46(8):2737-2748.

459 Zhang Bing, Song Xian-Fang, Zhang Ying-Hua, Han Dong-Mei, Yang Li-Hu, Tang Chang-Yuan. Relationship between surface water
460 and groundwater in the second Songhua River basin[J]. *Advances in Water Science*, 2014, 25(3):336-347.

461 [Zhang Mingjun, Wang Shengjie. A review of precipitation isotope studies in China: Basic pattern and hydrological process\[J\].
462 *Journal of Geographical Sciences*, 2016, 26 \(7\): 921-938.-](#)

463 Zhu Xin-Jun, Wang Zhong-Gen , Li Jian-Xin, Yu Lei, Wang Jin-Gui. Applications of SWAT model in Zhang Wei River Basin[J].
464 *Progress in Geography*, 2006, 25(5):106-111.

465 Zhang Ying-Hua, Wu Yan-Qing, Wen Xiao-Hu, Su Jian-Ping. Application of environmental isotopes in water cycle[J]. *Advances in
466 Water Science*, 2006, 17(5):738-747.